

KOKKUPANEKUJUHEND / ASSEMBLY INSTRUCTION

TOOL ADMIRAL / CHAIR ADMIRAL 40046





ENNE TÖÖ ALUSTAMIST LUGEGE JUHEND LÄBI JA SÄILITAGE HILISEMAKS KASUTAMISEKS!



1. PAKKIKGE KÕIK OSAD LAHTI, KONTROLLIGE ÜLE JA VÕRRELGE ALLTOODUD LOETELUGA.
2. ASETAGE KÕIK OSAD PUHTALE, TASASELE ALUSPINNALE (NÄITEKS VAIBALE). VÄLTIGE DETAILIDE KAHJUSTAMIST TÖÖ KÄIGUS.
3. JÄRGIGE JUHENDIT SAMM-SAMMULT.
4. ÄRGE KEERAKE POLTE LÖPUNI KINNI ENNE, KUI KÕIK OSAD ON KOKKU PANDUD. ÄRGE PINGUTAGE POLTE LIIGSELT.

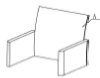

READ AND SAVE BELOW INSTRUCTIONS BEFORE ASSEMBLY!

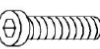
1. PLEASE SEPARATE AND IDENTIFY ALL PARTS, MAKING SURE THAT YOU HAVE ALL OF THE PARTS LISTED.
2. TO AVOID ANY SCRATCHES DURING ASSEMBLY, PLEASE ASSEMBLE ON A SOFT MAT OR SIMILAR.
3. PLEASE ASSEMBLE STEP BY STEP AND FOLLOW THE INSTRUCTIONS.
4. DO NOT COMPLETELY FASTEN EACH BOLT UNTIL ALL THE BOLTS ARE PROPERLY FIXED. DO NOT OVER FASTEN.

OSA / PART			KOGUS / QTY
A		Toolikorpus Chair back	1
B		Alusraam Chair base	1
C		Polt / Bolt M6x55	4

OSA / PART			KOGUS / QTY
D		Seib Washer	4
E		Poldikate Bolt cap	4
F		Allen Key	1

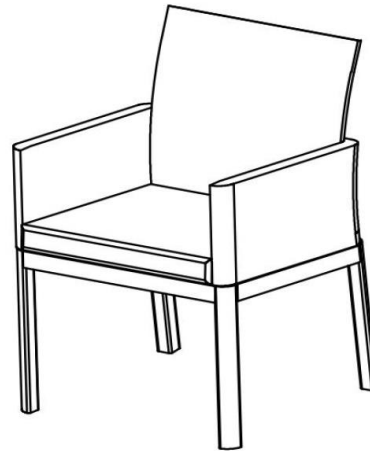
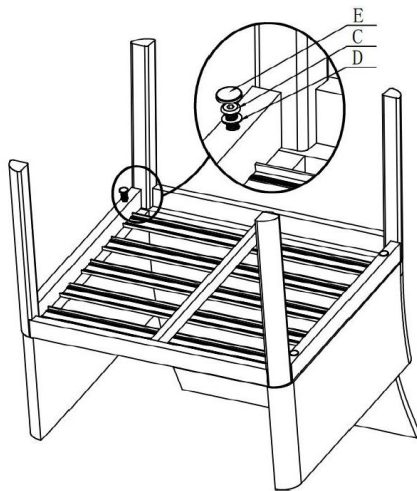

SAMM 1

Kinnitage toolikorpus (A) alusraami (B) külge. Kasutage polte (C) ja seibe (D) ning võtit (F). Paigaldage poldikatted. Tõstke tool õigetpidi ja asetage padi kohale. Nüüd on tool kasutamiseks valmis.

STEP 1

Attach chair base (B) to chair back (A) by using bolts (C) and washers (D) with allen key (F). Please cover bolt caps (E) after you assemble all bolts. Make the chair on right position, put cushions on the seat, now your products are ready for use.