

B007GB001/801

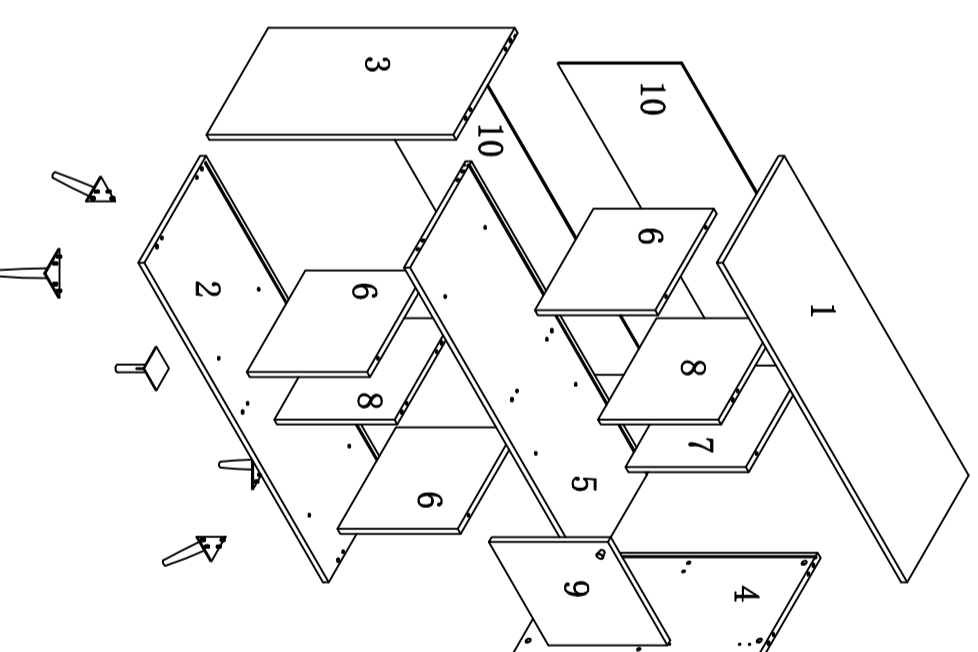
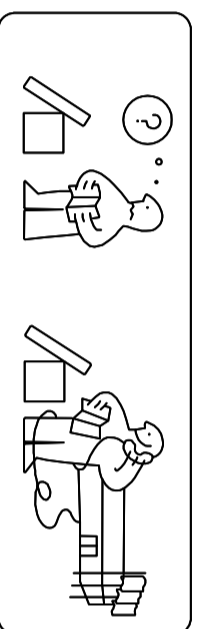
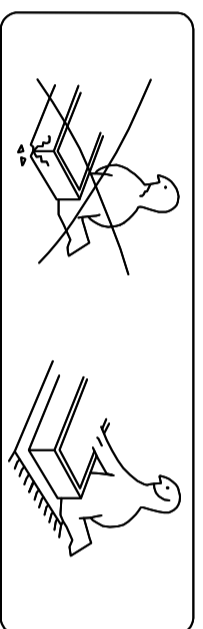
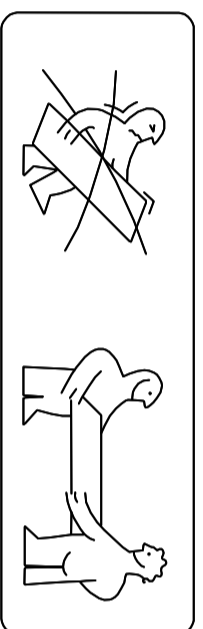
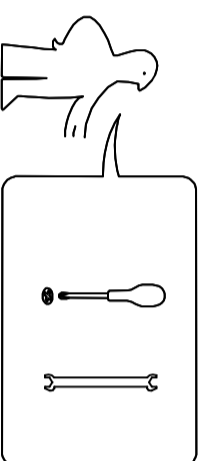
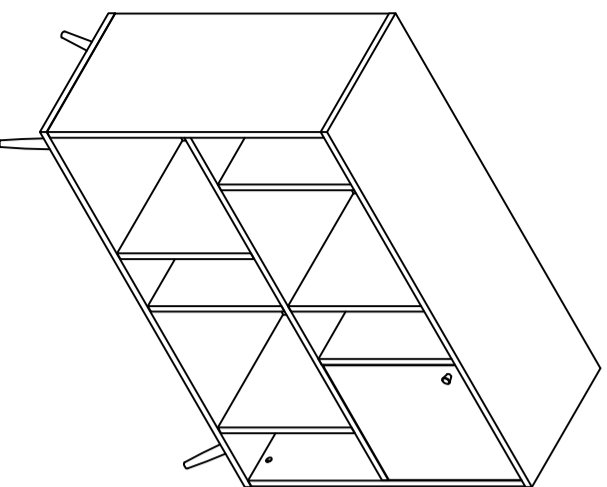

NO.	SIZE	QTY
1	1183*396*19	1
2	1183*396*19	1
3	791*395*19	1
4	791*395*19	1
5	1143*394*19	1
6	386*376*19	3
7	386*376*19	1
8	386*376*19	2
9	382*382*18	1
10	1153*396*5	2

A	big bend	2set	B	$\phi 18*10H20$	1pcs	C	M3*12	1pcs
D	M6*42	20pcs	E	$\phi 15*13.5$	20pcs	F	$\phi 8*30$	36pcs
G	/	12set	H	/	1set	I	30.5*16*10.5	1pcs
J	M3.5*12	3pcs	K	W90D90H150	4PCS	L	W80D80H150	1pcs
M	M6*16	19pcs						

STEP 1:

D	M6*42	2pcs	E	$\phi 15*13.5$	2pcs	F	$\phi 8*30$	6pcs
---	-------	------	---	----------------	------	---	-------------	------

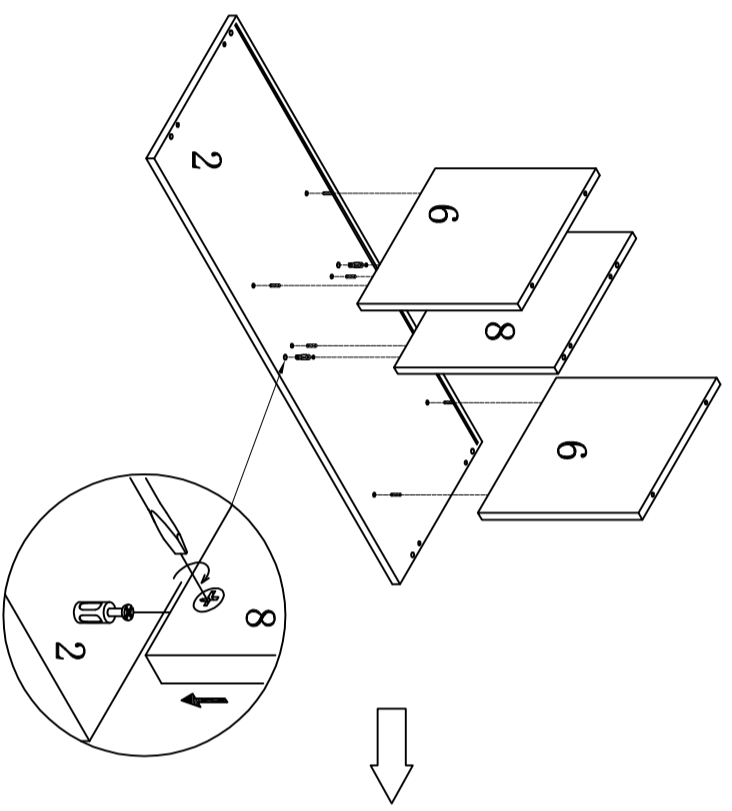

STEP 2:

D	M6*42	4pcs	E	$\phi 15*13.5$	4pcs	F	$\phi 8*30$	4pcs
---	-------	------	---	----------------	------	---	-------------	------

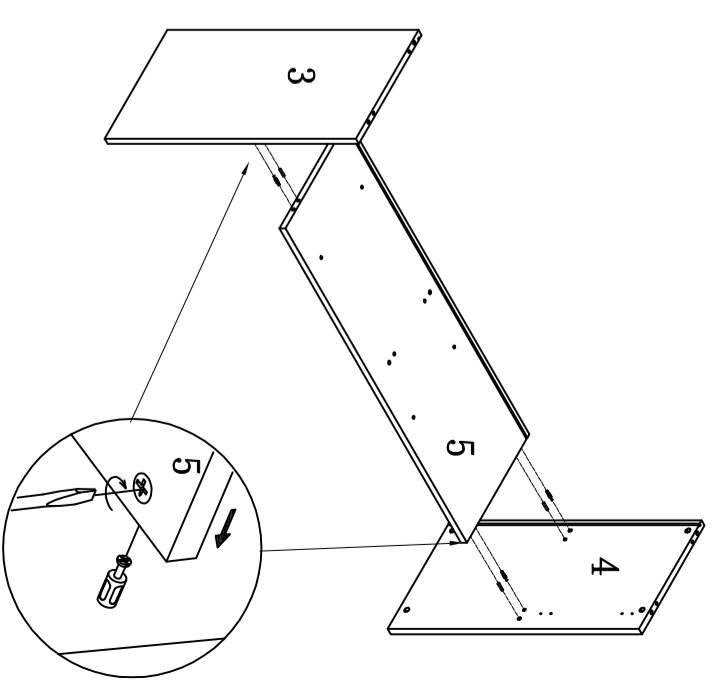

STEP 3:

D	M6*42	6pcs	E	φ 15*13.5	6pcs
			F	φ3*30	10pcs

STEP 4:

D	M6*42	8pcs	E	φ 15*13.5	8pcs	F	φ3*30	16pcs	I	
									J	
									M3.5*12	2pcs

STEP 5:

A	big bend	2set	B	φ 18*10H20	1pcs
			C	M3*12	1pcs

J	M3.5*12	1pcs
---	---------	------

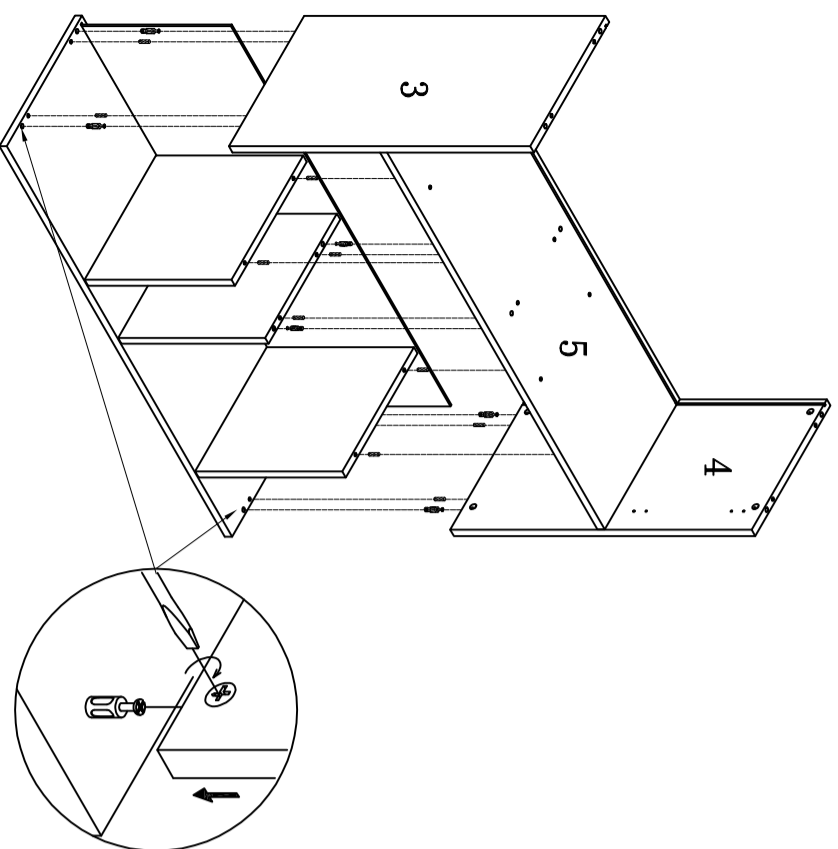

STEP 6:

K	W90D90H150	4PCS	L	W80D80H150	1pcs
			M	M6*16	19pcs

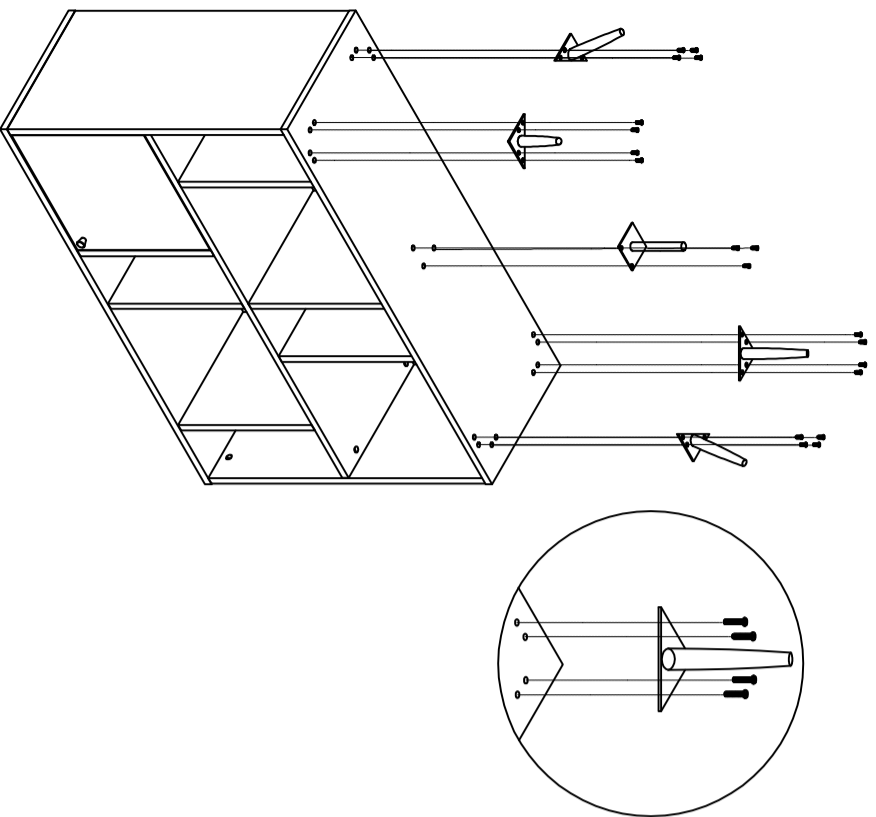

STEP 7:

G	/	12set
---	---	-------

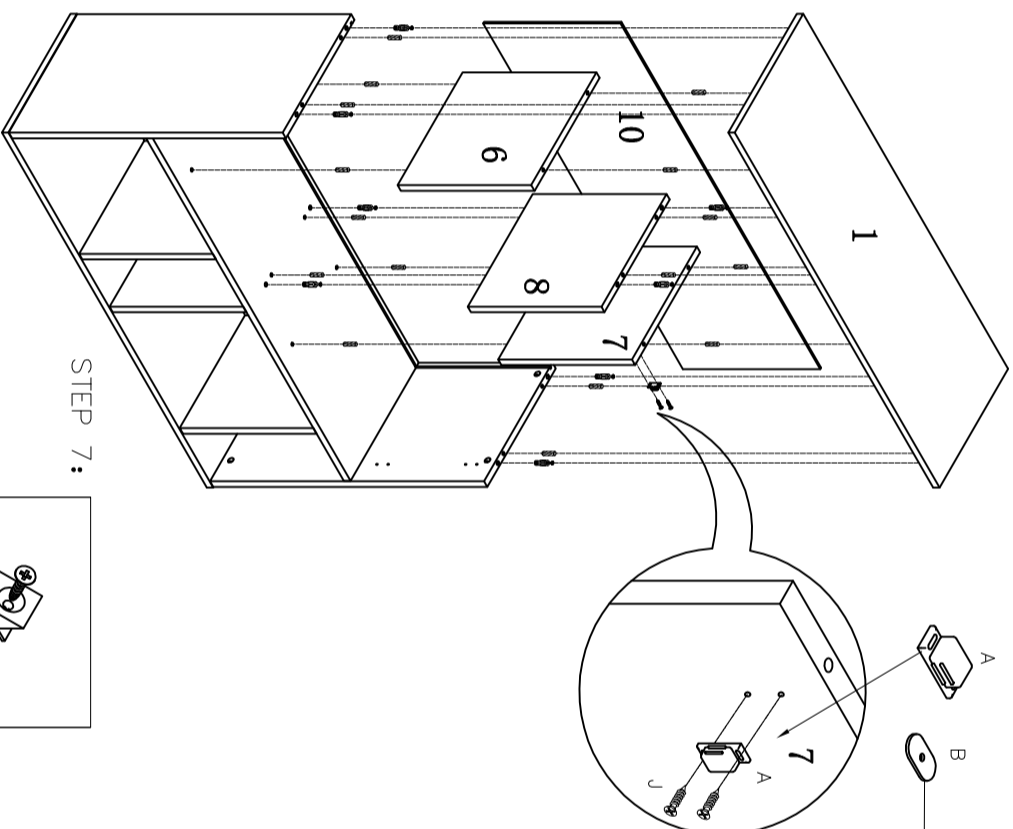

STEP 8:

H	/	1set	X2	X2	X2	X2	X2	X1
---	---	------	----	----	----	----	----	----

